



Made In USA



Cartoning, Trayforming, Case Packing FOR CRAFT BREWERS



Econocorp provides simple, compact and affordable packaging systems for cans and bottles for moderate volume production.

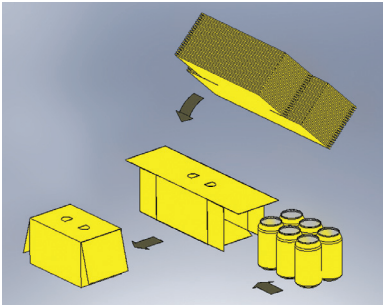

The E2000 or Spartan ...

Automatically conveys, collates and loads cans into multi-pack cartons that are erected and glue sealed. Typically handles cartons for 12 and/or 16 ounce cans.

E2000

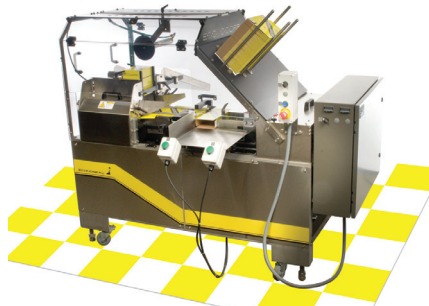

Up to 15 Cartons/Minute



Spartan



Up to 35 Cartons/Minute

Our Customers Are Thrilled:

“Econocorp provides us with the versatility we need to keep up with growing demand at our brewery. We chose the Spartan for our packaging needs after having great success with the E2000. Both of these machines allow us to package in both a 4 pack and 8 pack recyclable box that really helps us stand out on crowded beer shelves. Flexibility, reliability, and labor savings have made it an easy choice for us to make Econocorp our partner in our growth trajectory.”

Tim O’Leary

Kettlehouse Brewing Company LLC
Missoula, Montana.



ECONOCORP TWINSEAL CARTON GLUING MACHINE

The Econocorp Twinseal carton gluing machine offers craft brewers an economical, simple and compact machine that makes low to moderate volume can packaging in cartons a reality.

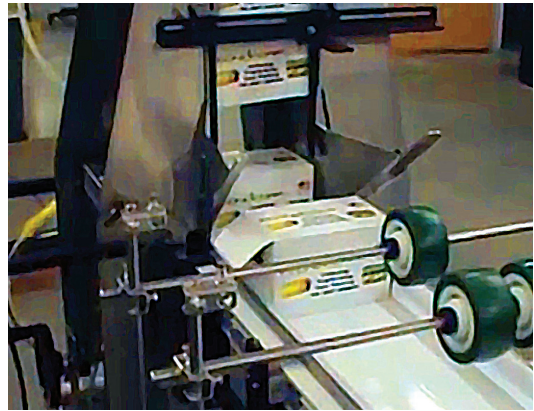

ECONOCORP TRAYFORMING

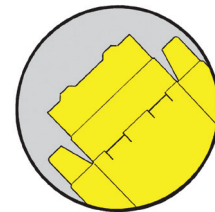
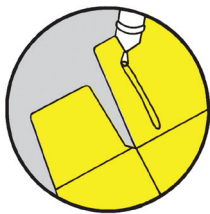

Econocorp Trayformers accommodate "Open Top Glue" or "Rollover Locking" trays with speeds up to 25 trays/minute. Ideal for 24 count trays of cans or bottles



ECONOCORP SPARTAN WRAPAROUND TRAYPACKER

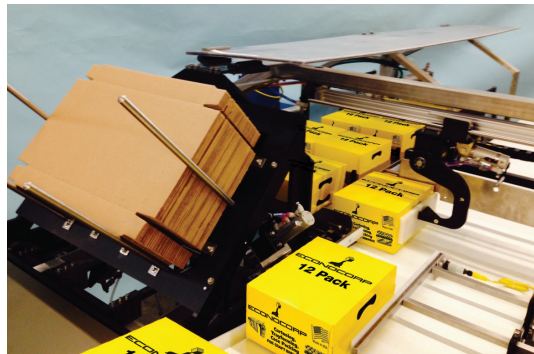
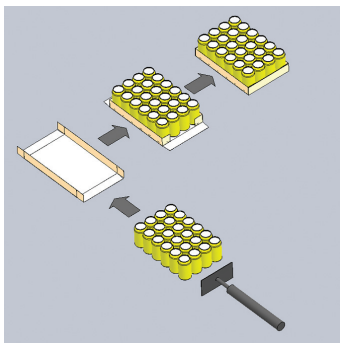

The Spartan Wraparound Traypacker accommodates trays for cans or bottles up to 25 trays/minute.



72 Pacella Park Drive, Randolph, MA 02368
Telephone: +1 (781) 986-7500 Fax: +1 (781) 986-1553
www.econocorp.com e-mail: info@econocorp.com

